

# Quick Installation Guide

6GHz AX2400 Fixed Wireless Access

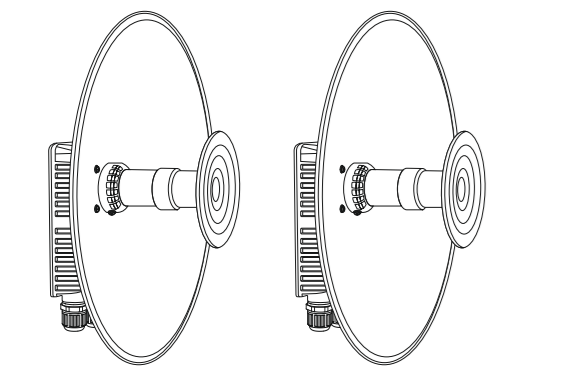

WI-FW5625

## 1. Packing Content

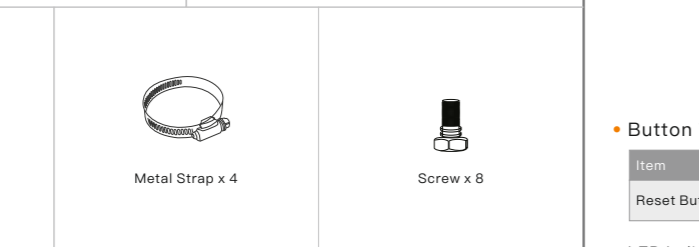
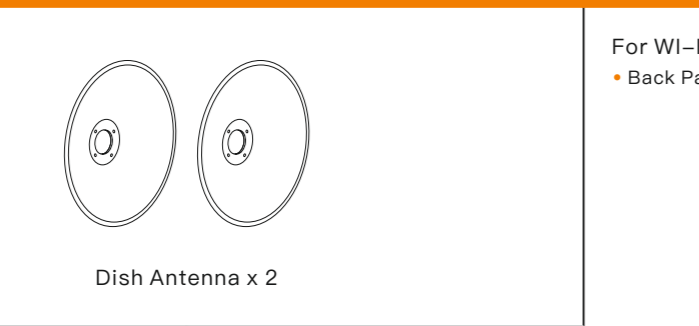

## 2. Appearance Overview

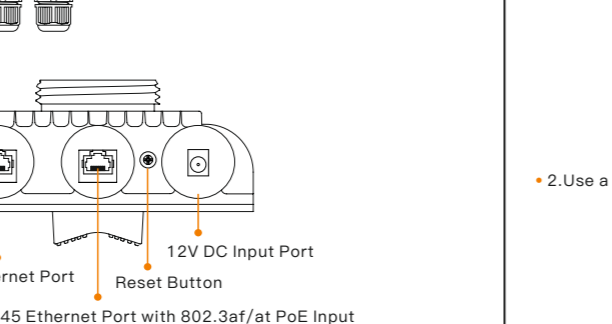
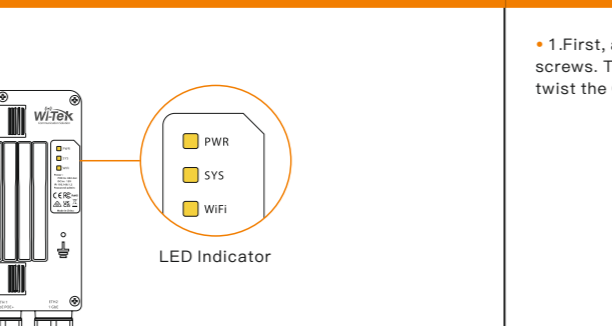

• Button indicator

Item	Description
Reset Button	Press and hold the "Reset" button for more than five seconds to restore the device to its factory settings mode.

• LED Indicator

Item	Status	Description
PWR	On	The device is powered on
	Off	The device is powered off
SYS	On	The system is working normally
	Off	The system is not working
Wi-Fi	On	The Wireless function is enabled
	Off	The Wireless function is disabled

## 3. Device Installation

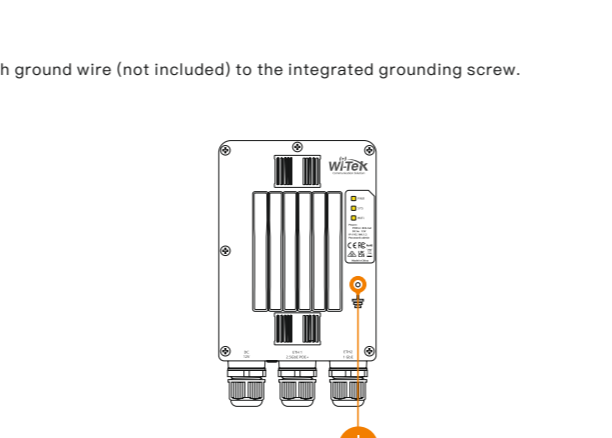
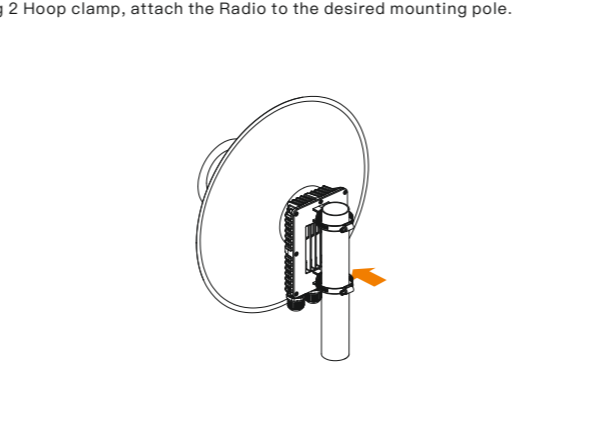
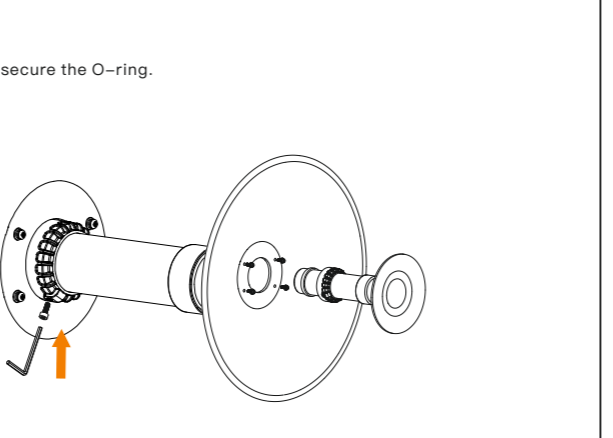
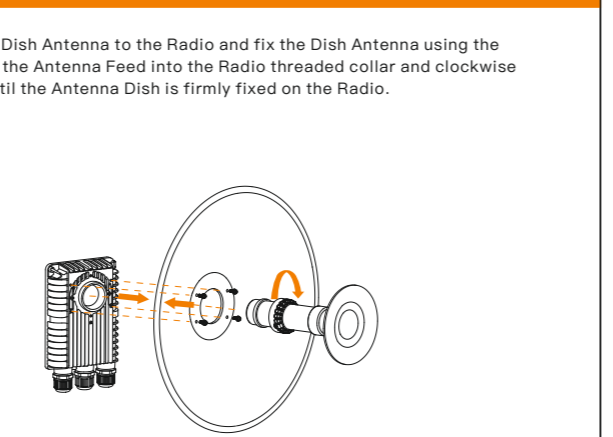

## 4. Application

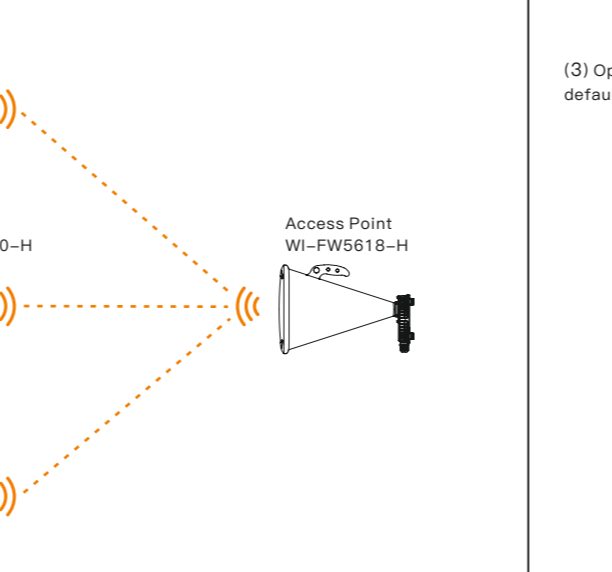

## 5. Web Management

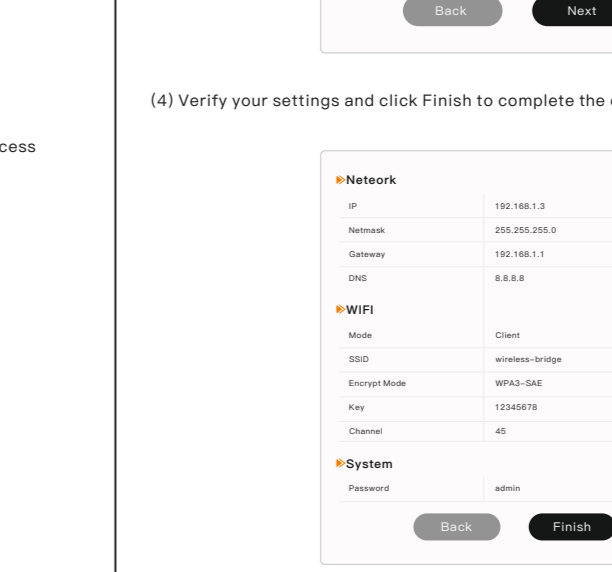
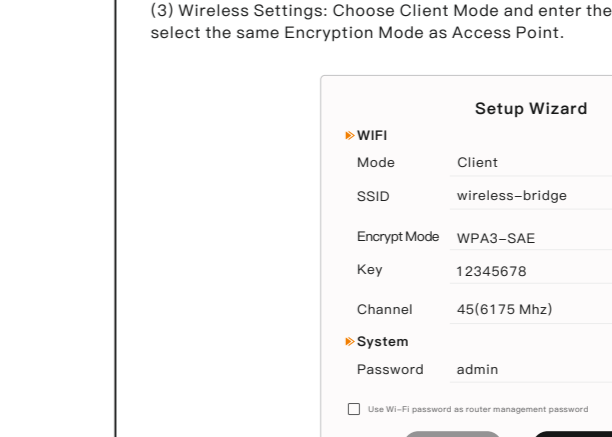
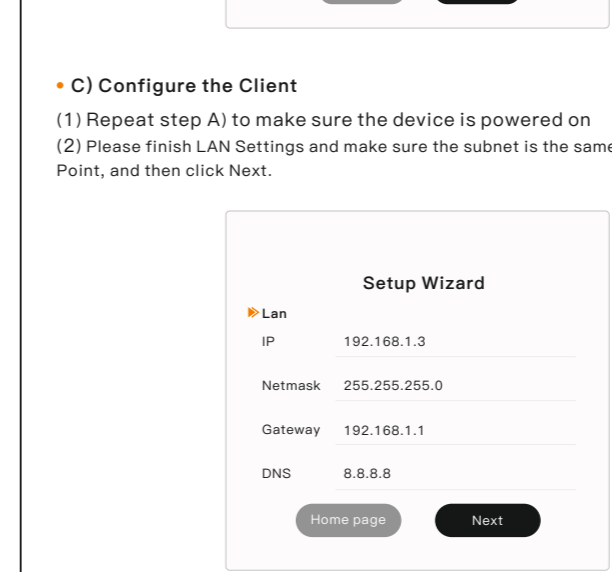
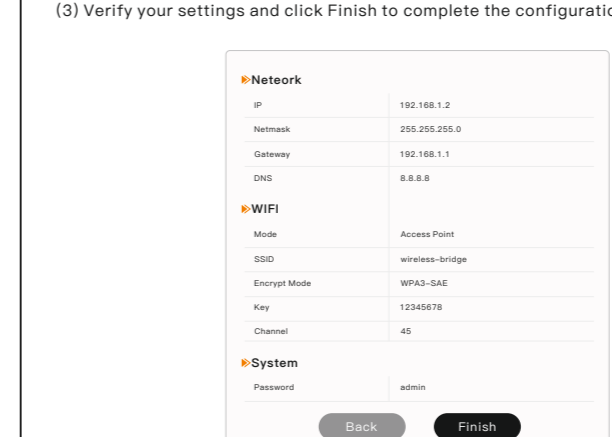
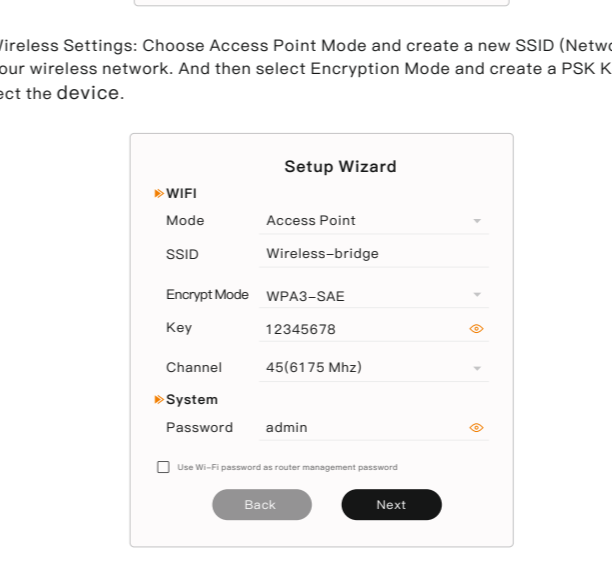
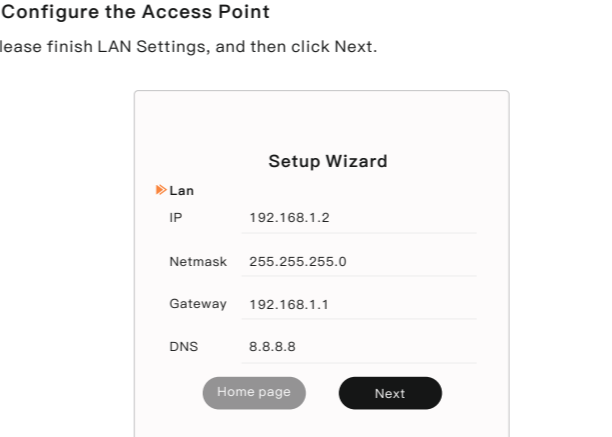
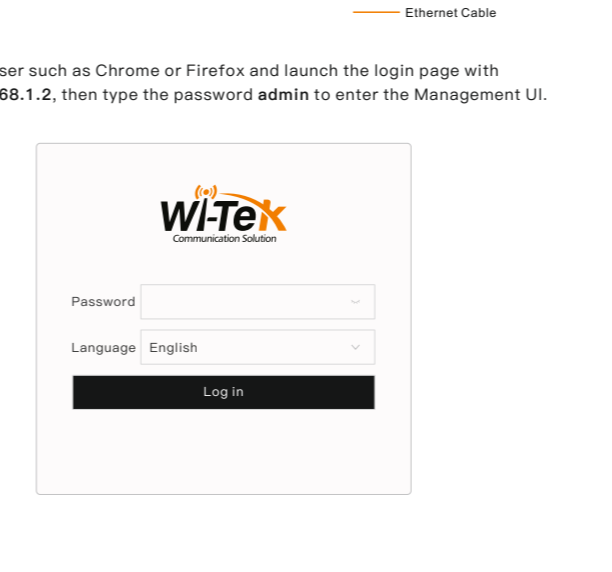
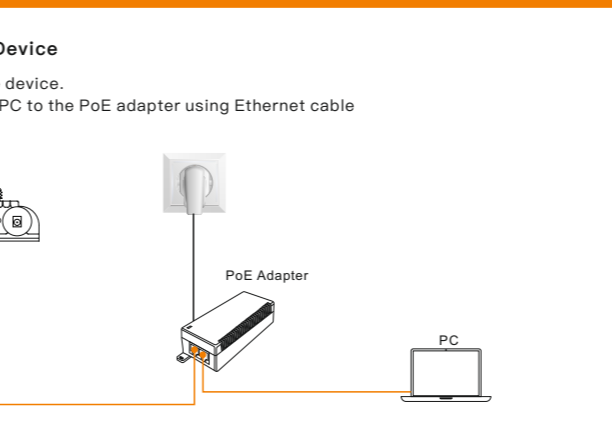

## Warranty Card

Username	
Address	
Telephone No.	
Purchase Shop	
Purchase Address	
Product Model No.	
Purchase Time	
Serial No.	
Dealer Signature	

- If the product defects within the warranty period, we will provide professional maintenance service.
- Proof of purchase and a complete product serial number are required to receive any services guaranteed as part of the limited warranty.
- Any other defects that are not caused by workmanship or product quality, such as natural disasters, water damage, extreme thermal or environmental conditions, sticker damaged, warranty card loss will disqualify the product from limited warranty.



Wireless-Tek Technology Limited  
 Address: Building 3, Units 1801-1807, 1812, Huaqiang Era Plaza, Tangwei Community, Fuhai Street, Bao'an District, Shenzhen City, Guangdong Province, China.  
 Website: www.wireless-tek.com  
 Tel: 86-0755-32811290  
 Email: sales@wireless-tek.com  
 Technical Support: tech@wireless-tek.com

