

WI-AP520AX-D

1. Packing Content

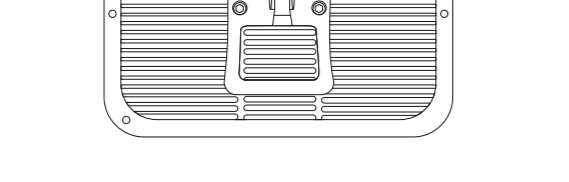
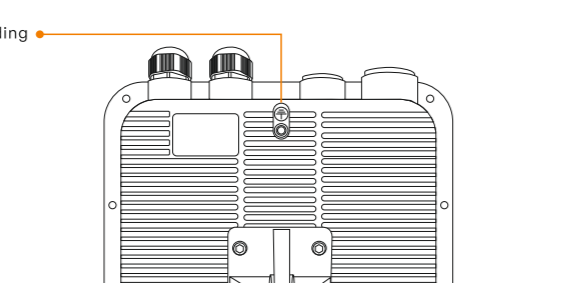
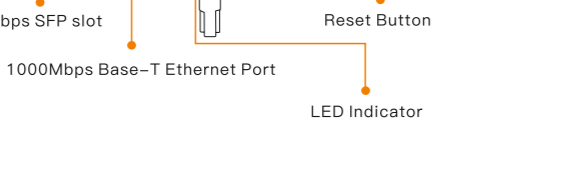
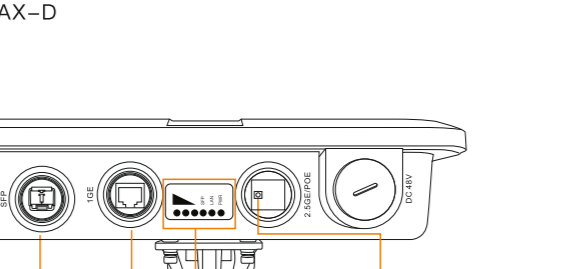

2. Appearance Overview

For WI-AP520AX-D

• Side Panel

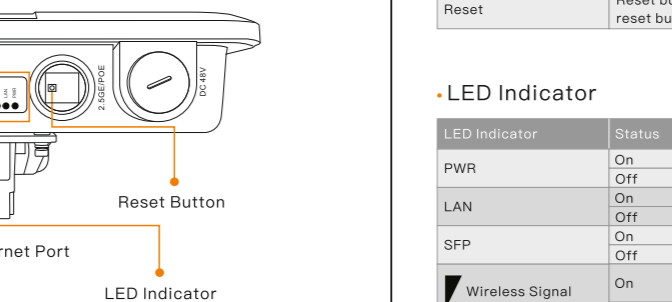

• Rear Panel

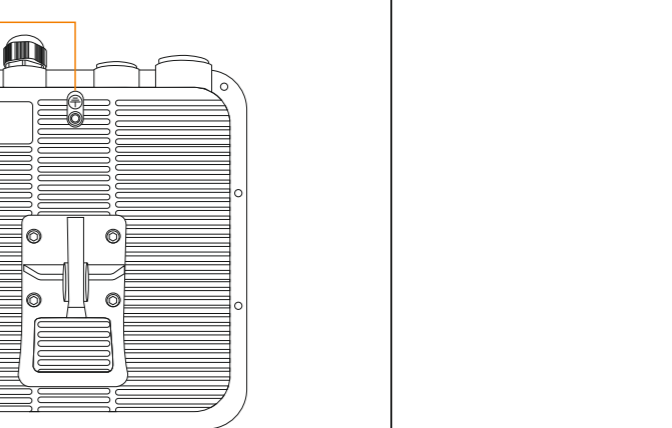

• Port and Button

Item	Description
LAN	1000Mbps Base-T Ethernet Port, which supports 802.3at PoE Input
SFP	2.5Gbps SFP slot
Reset	Reset button, which is used to restore the factory. Holding down the reset button for 8 seconds to revert to factory settings.

• LED Indicator

LED Indicator	Status	Description
PWR	On	The device is powered on
	Off	The device is powered off
LAN	On	The port is linked
	Off	The port is disconnected
SFP	On	The port is linked
	Off	The port is disconnected
Wireless Signal	On	The device works at 5GHz and The more the number of signal lights, the greater the signal strength.
	Off	5G Wi-Fi disabled

3. Mounting

• Pole Installation

• 1. Fasten the mounting bracket with screws

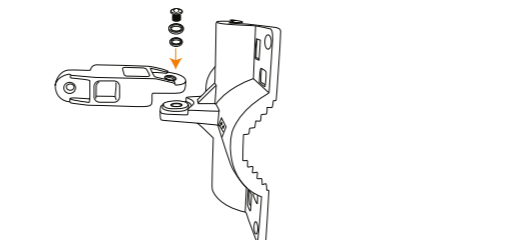

• 2. Secure the mounting bracket to the pole

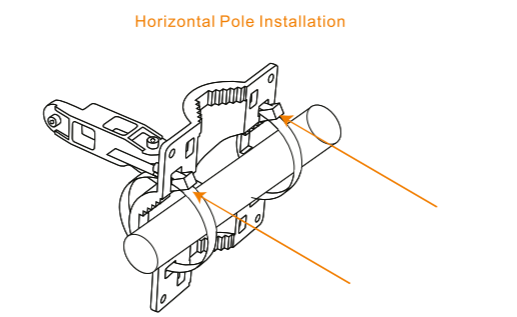

• 3. Fix the bracket to the product and tighten the screws

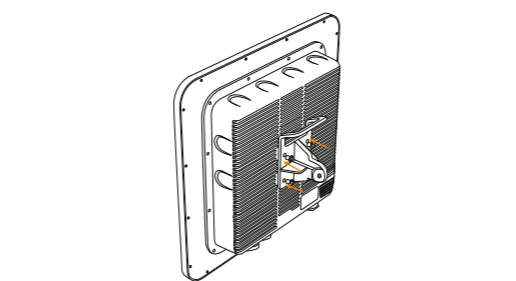

4. Configuration Method

Please connect computer to the AP by Ethernet cable.

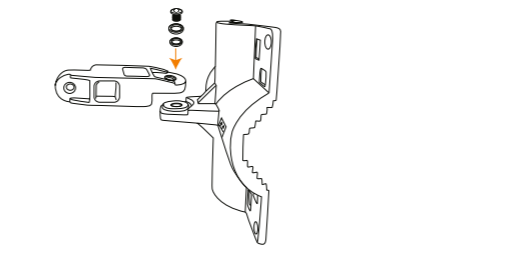

Step 1. On the computer, please set the static IP under the same subnet with AP, 192.168.1.xx

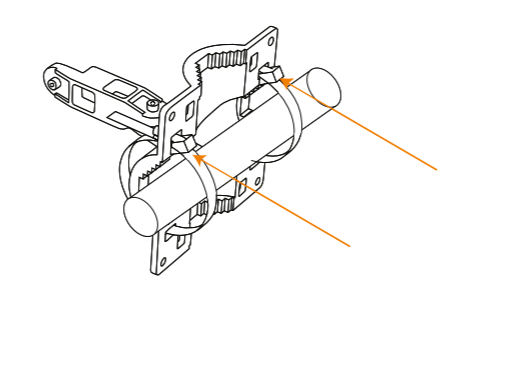

5. Cloud management settings

Step 1 Launch your web browser then enter <http://cloud2.wireless-tek.com> in the address bar.

Step 2 Register an account password by user name or email.

Step 3 log in to the cloud account with the account password after registration.

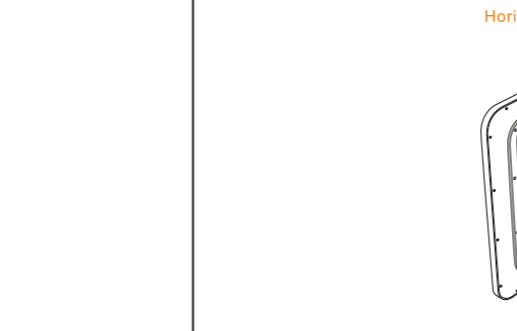

After the login is successful, the steps to bind the device on the cloud account are as follows:

(1) Click ADD NETWORK

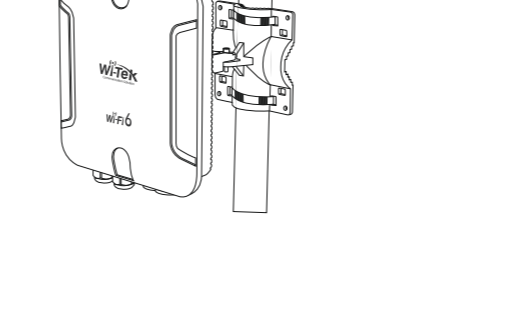

(2) Fill in the group name and location, click save.

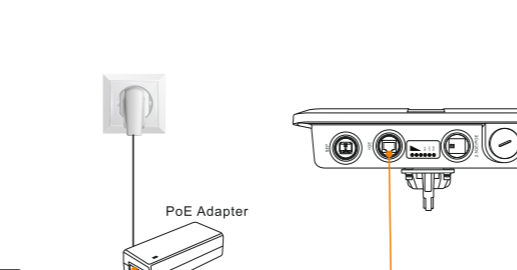

(3) And click next.



(4) Enter serial number, click ADD to create and click FINISH, the configuration is complete. Note: The 17-digit SN code of the Add device is shown on the sticker on the back of the device.

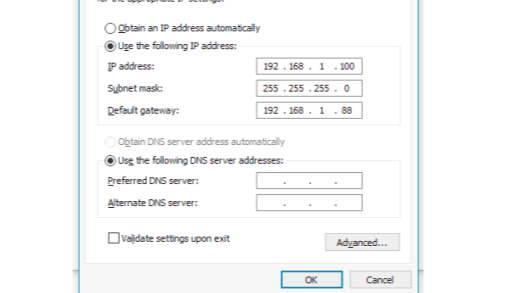

(5) In the relevant device options, you can see the bound device information.

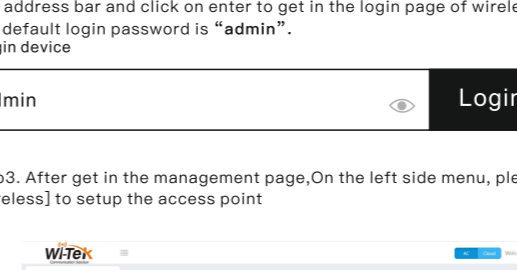

(6) Click Tunnel, Select binding device type, click EWEB to log in to the device.

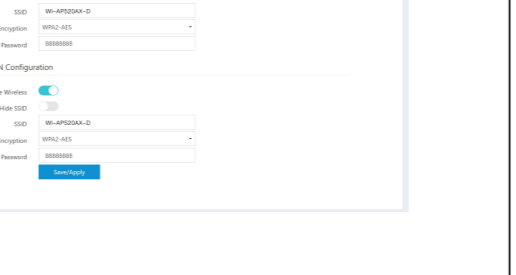

(7) Click ADD NETWORK

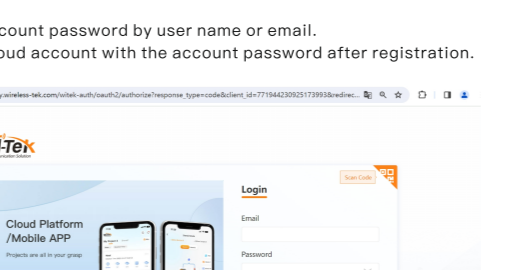

(8) Enter serial number, click ADD to create and click FINISH, the configuration is complete. Note: The 17-digit SN code of the Add device is shown on the sticker on the back of the device.

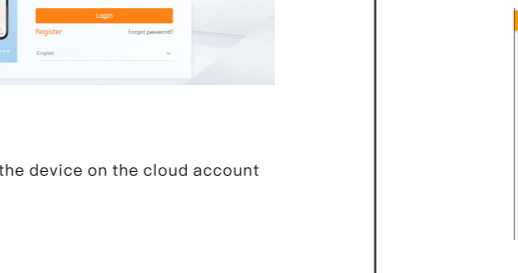

(9) Click Tunnel, Select binding device type, click EWEB to log in to the device.

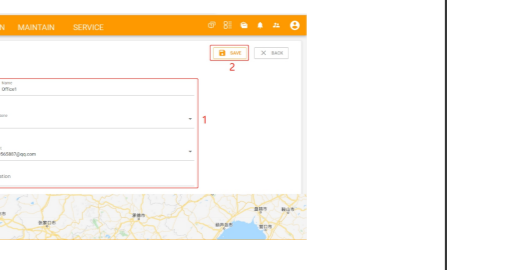

(10) Enter serial number, click ADD to create and click FINISH, the configuration is complete. Note: The 17-digit SN code of the Add device is shown on the sticker on the back of the device.



(11) Click Tunnel, Select binding device type, click EWEB to log in to the device.

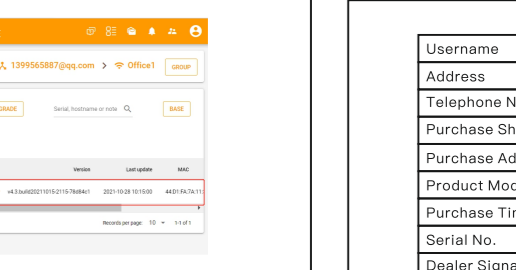

(12) Enter serial number, click ADD to create and click FINISH, the configuration is complete. Note: The 17-digit SN code of the Add device is shown on the sticker on the back of the device.

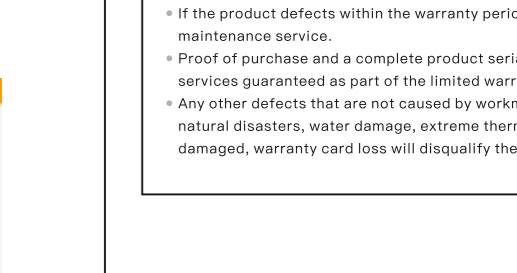

(13) Click Tunnel, Select binding device type, click EWEB to log in to the device.



(14) Enter serial number, click ADD to create and click FINISH, the configuration is complete. Note: The 17-digit SN code of the Add device is shown on the sticker on the back of the device.

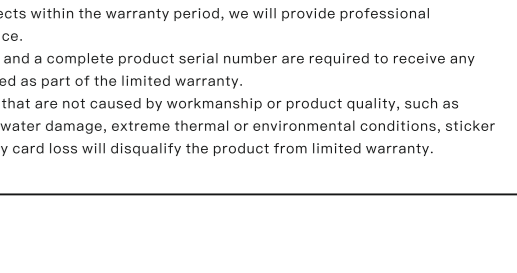

(15) Click Tunnel, Select binding device type, click EWEB to log in to the device.

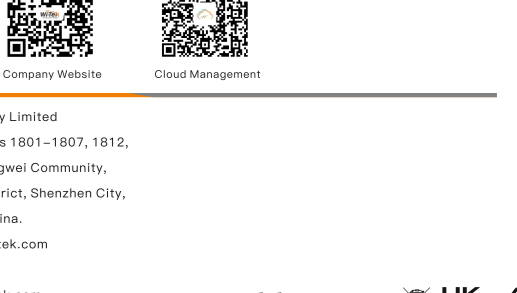

(16) Click Tunnel, Select binding device type, click EWEB to log in to the device.

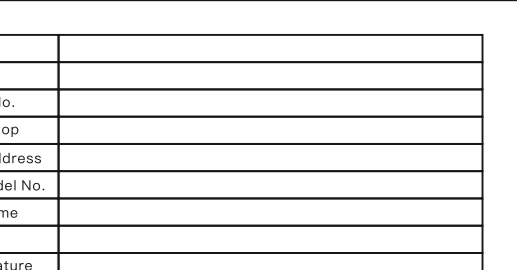

(17) Click Tunnel, Select binding device type, click EWEB to log in to the device.

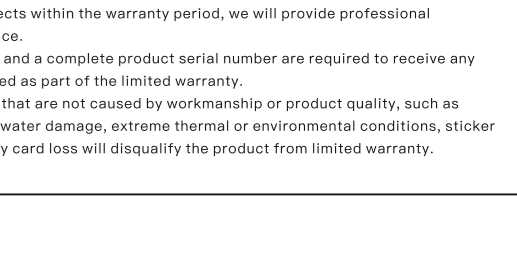

(18) Click Tunnel, Select binding device type, click EWEB to log in to the device.

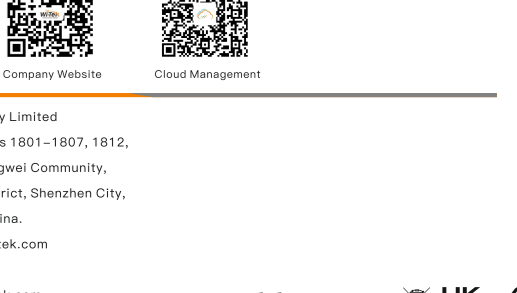

(19) Click Tunnel, Select binding device type, click EWEB to log in to the device.

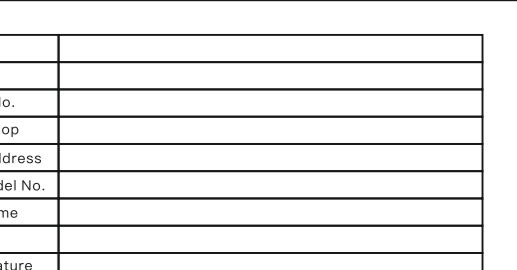

(20) Click Tunnel, Select binding device type, click EWEB to log in to the device.

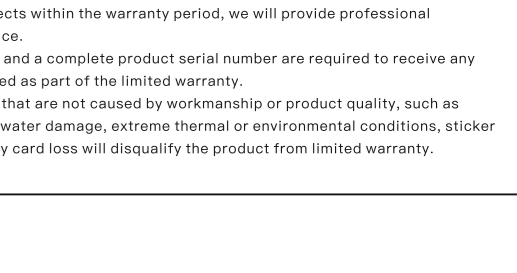

(21) Click Tunnel, Select binding device type, click EWEB to log in to the device.

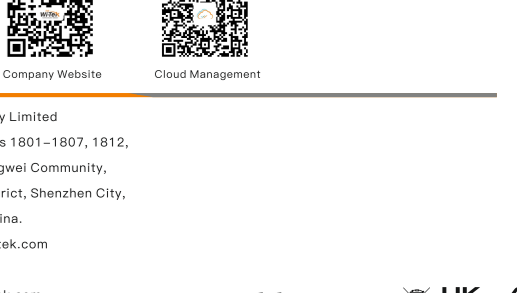

(22) Click Tunnel, Select binding device type, click EWEB to log in to the device.

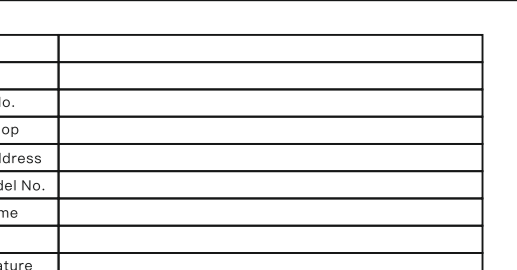

(23) Click Tunnel, Select binding device type, click EWEB to log in to the device.

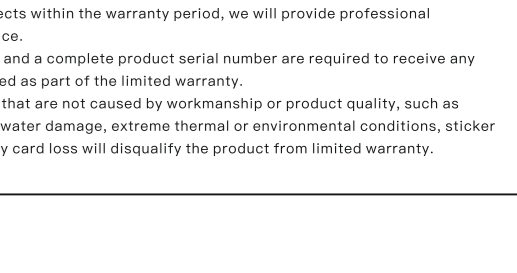

(24) Click Tunnel, Select binding device type, click EWEB to log in to the device.

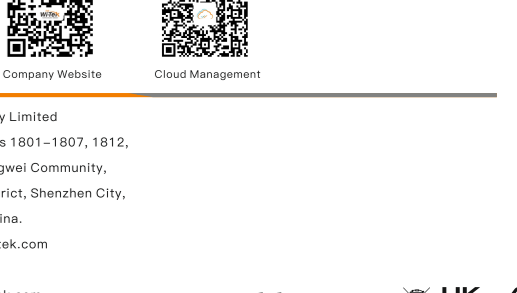

(25) Click Tunnel, Select binding device type, click EWEB to log in to the device.

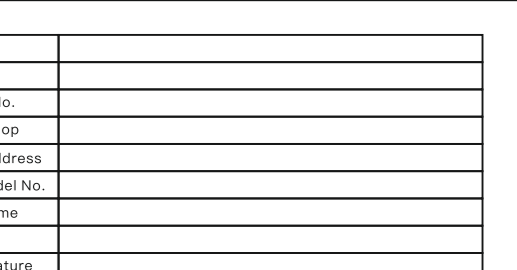

(26) Click Tunnel, Select binding device type, click EWEB to log in to the device.

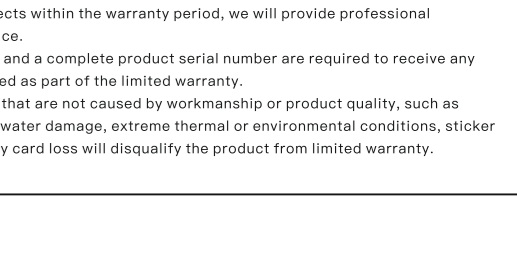

(27) Click Tunnel, Select binding device type, click EWEB to log in to the device.

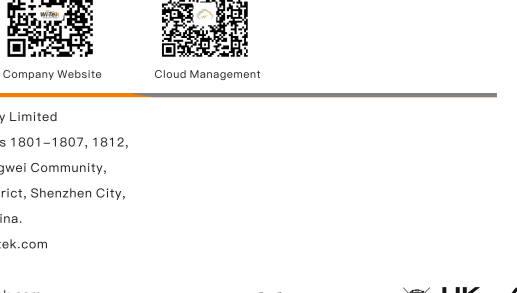

(28) Click Tunnel, Select binding device type, click EWEB to log in to the device.

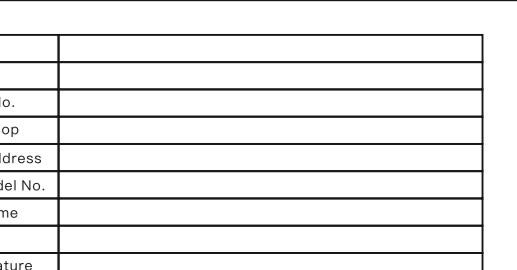

(29) Click Tunnel, Select binding device type, click EWEB to log in to the device.

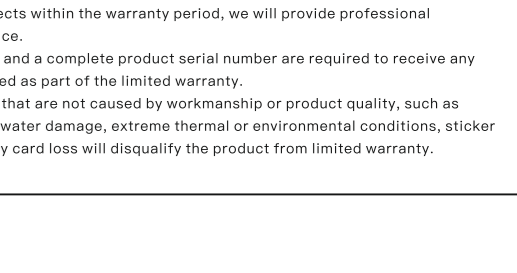

(30) Click Tunnel, Select binding device type, click EWEB to log in to the device.

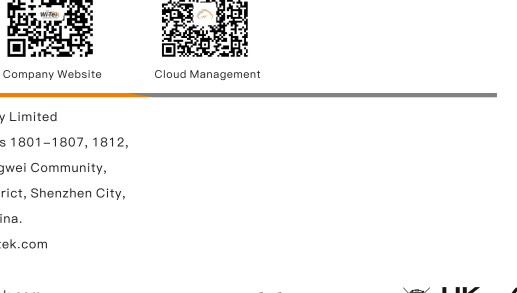

(31) Click Tunnel, Select binding device type, click EWEB to log in to the device.

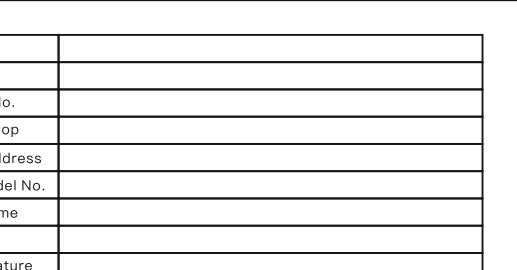

(32) Click Tunnel, Select binding device type, click EWEB to log in to the device.

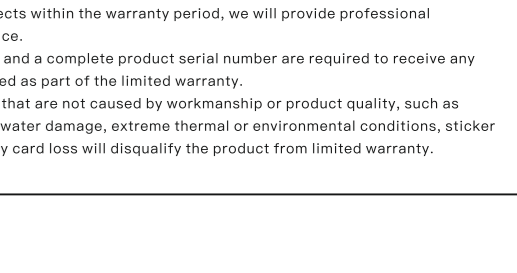

(33) Click Tunnel, Select binding device type, click EWEB to log in to the device.

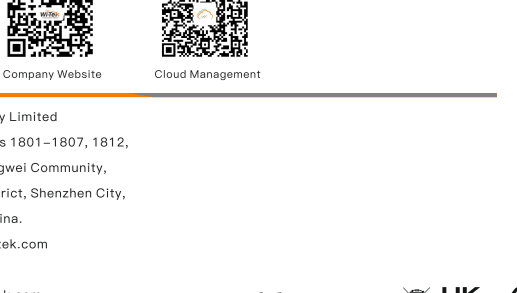

(34) Click Tunnel, Select binding device type, click EWEB to log in to the device.

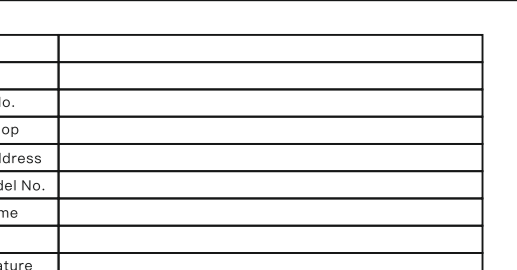

(35) Click Tunnel, Select binding device type, click EWEB to log in to the device.

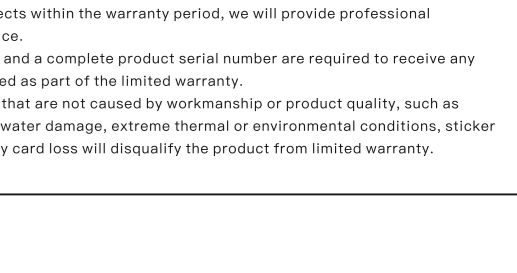

(36) Click Tunnel, Select binding device type, click EWEB to log in to the device.

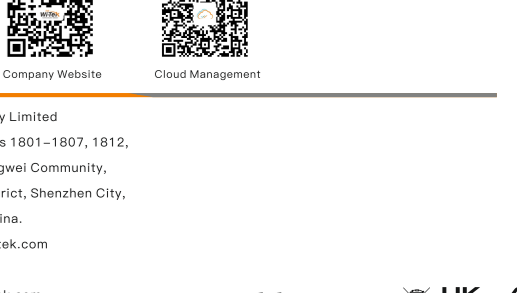

(37) Click Tunnel, Select binding device type, click EWEB to log in to the device.

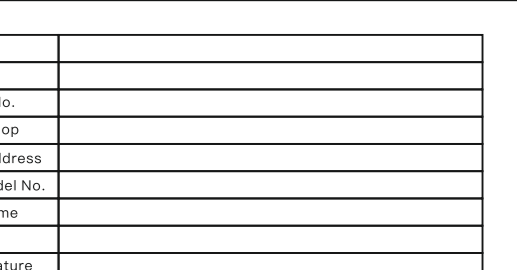

(38) Click Tunnel, Select binding device type, click EWEB to log in to the device.

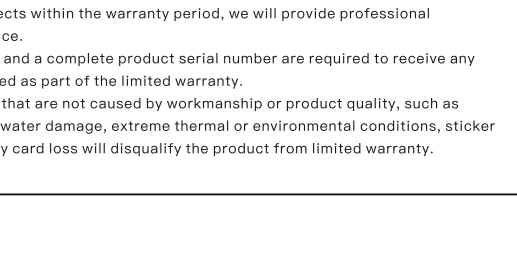

(39) Click Tunnel, Select binding device type, click EWEB to log in to the device.

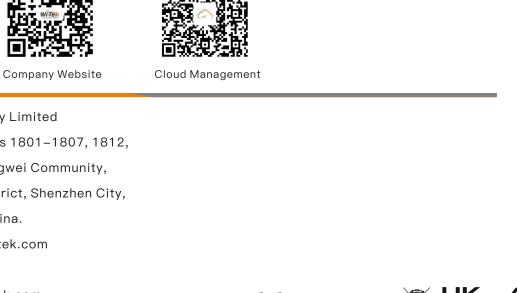

(40) Click Tunnel, Select binding device type, click EWEB to log in to the device.

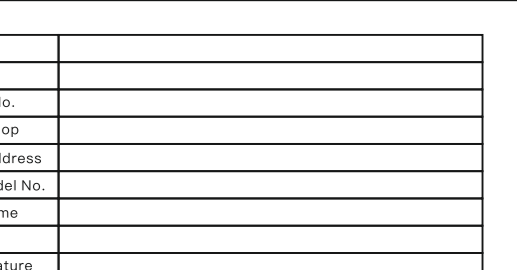

(41) Click Tunnel, Select binding device type, click EWEB to log in to the device.

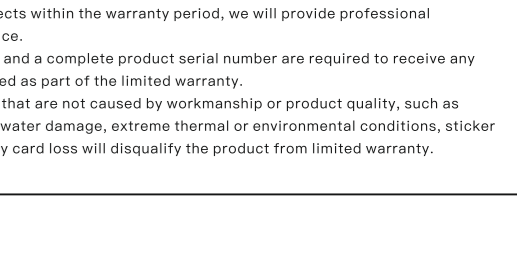

(42) Click Tunnel, Select binding device type, click EWEB to log in to the device.

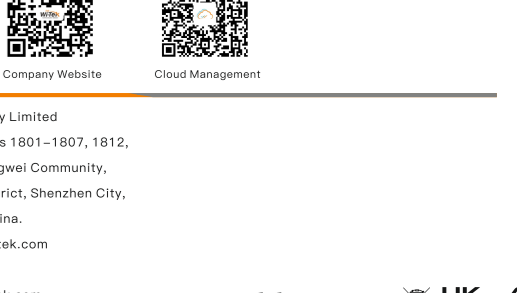

(43) Click Tunnel, Select binding device type, click EWEB to log in to the device.

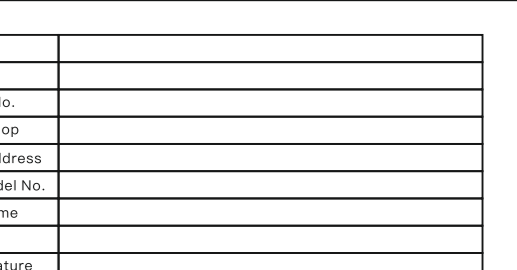

(44) Click Tunnel, Select binding device type, click EWEB to log in to the device.

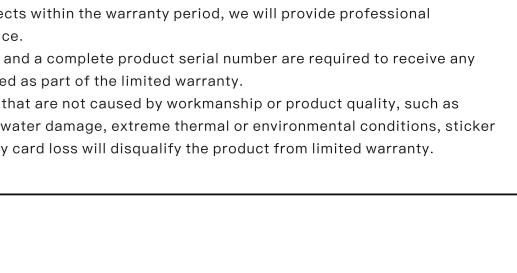

(45) Click Tunnel, Select binding device type, click EWEB to log in to the device.

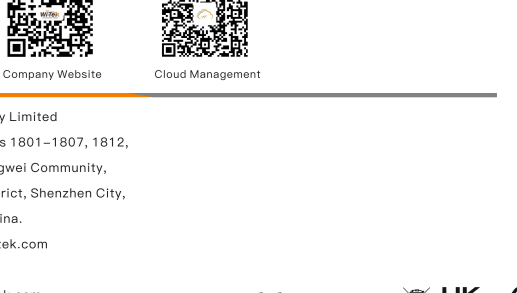

(46) Click Tunnel, Select binding device type, click EWEB to log in to the device.

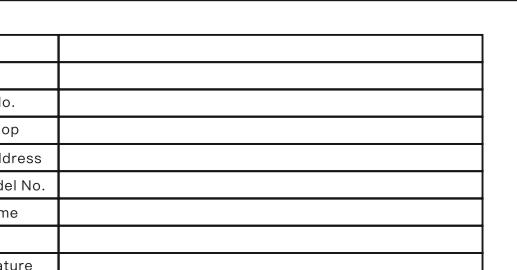

(47) Click Tunnel, Select binding device type, click EWEB to log in to the device.

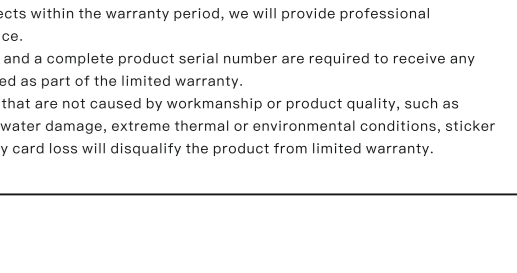

(48) Click Tunnel, Select binding device type, click EWEB to log in to the device.

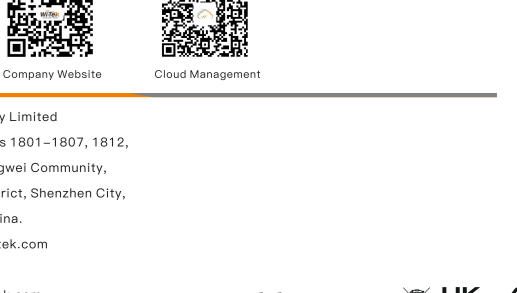

(49) Click Tunnel, Select binding device type, click EWEB to log in to the device.

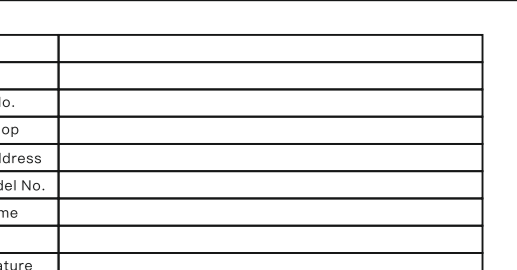

(50) Click Tunnel, Select binding device type, click EWEB to log in to the device.

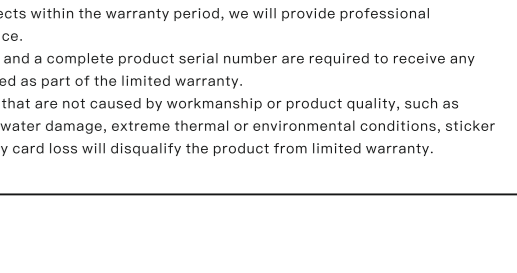

(51) Click Tunnel, Select binding device type, click EWEB to log in to the device.

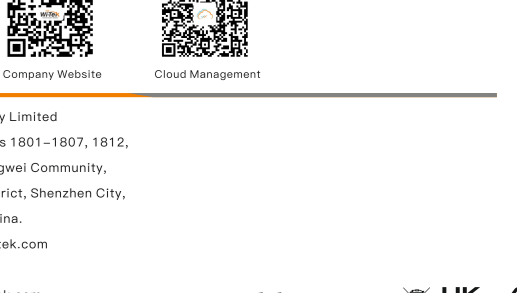

(52) Click Tunnel, Select binding device type, click EWEB to log in to the device.

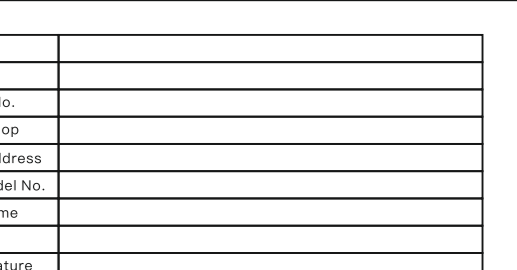

(53) Click Tunnel, Select binding device type, click EWEB to log in to the device.

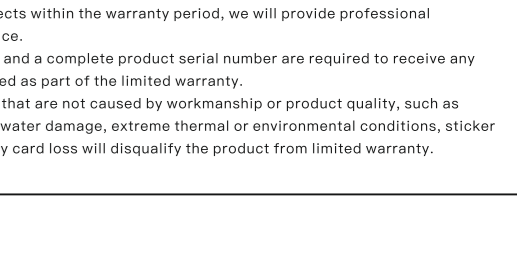

(54) Click Tunnel, Select binding device type, click EWEB to log in to the device.

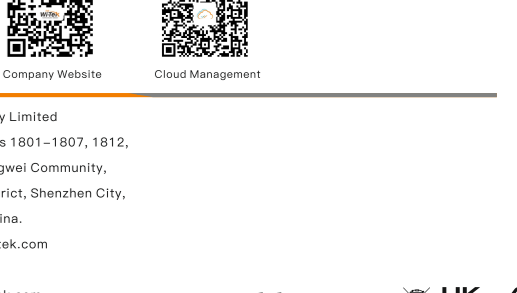

(55) Click Tunnel, Select binding device type, click EWEB to log in to the device.

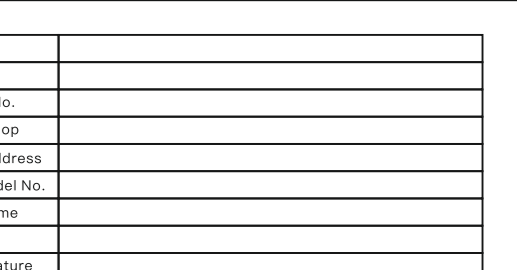

(56) Click Tunnel, Select binding device type, click EWEB to log in to the device.

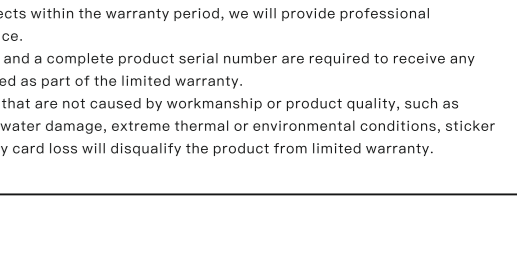

(57) Click Tunnel, Select binding device type, click EWEB to log in to the device.

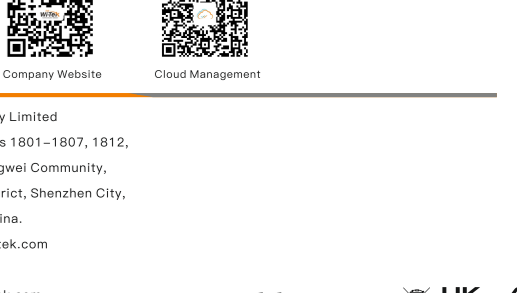

(58) Click Tunnel, Select binding device type, click EWEB to log in to the device.

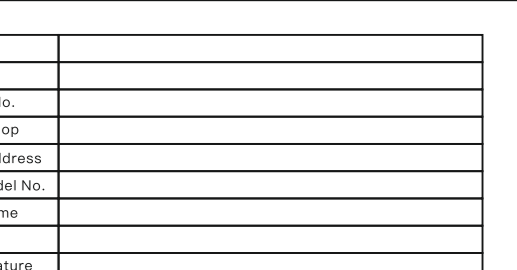

(59) Click Tunnel, Select binding device type, click EWEB to log in to the device.

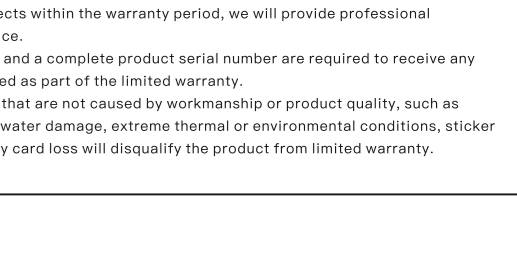

(60) Click Tunnel, Select binding device type, click EWEB to log in to the device.

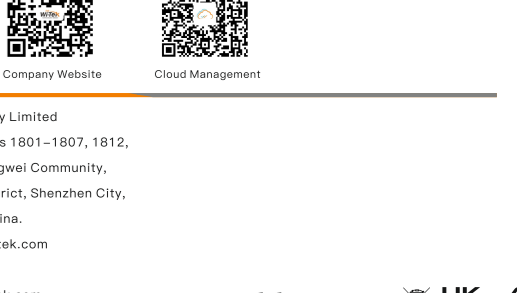

(61) Click Tunnel, Select binding device type, click EWEB to log in to the device.

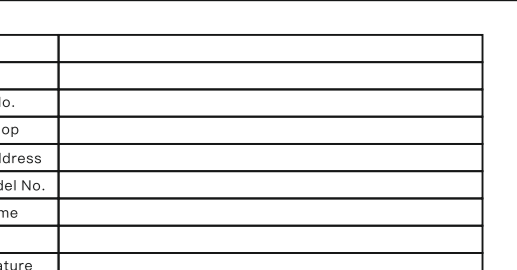

(62) Click Tunnel, Select binding device type, click EWEB to log in to the device.

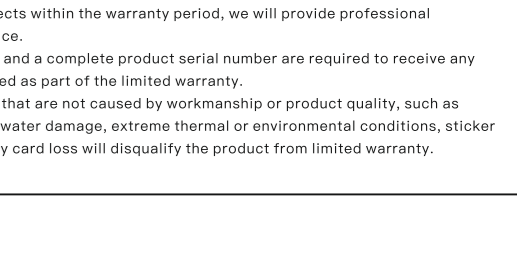

(63) Click Tunnel, Select binding device type, click EWEB to log in to the device.

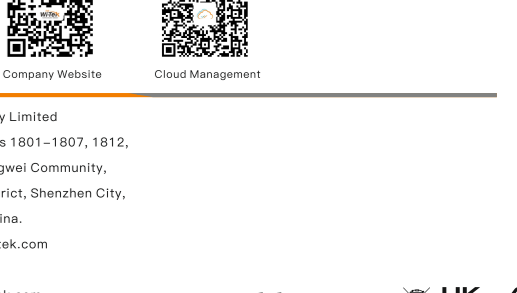

(64) Click Tunnel, Select binding device type, click EWEB to log in to the device.

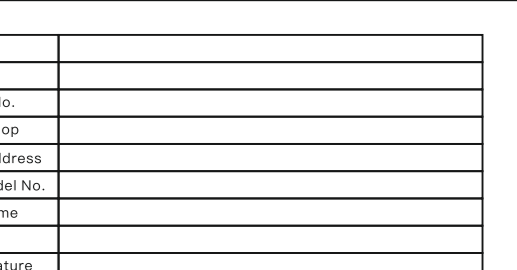

(65) Click Tunnel, Select binding device type, click EWEB to log in to the device.

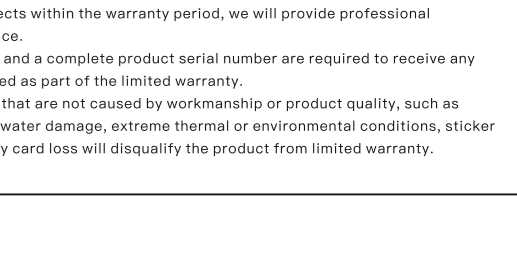

(66) Click Tunnel, Select binding device type, click EWEB to log in to the device.

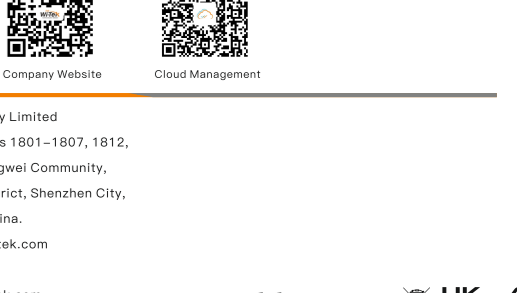

(67) Click Tunnel, Select binding device type, click EWEB to log in to the device.

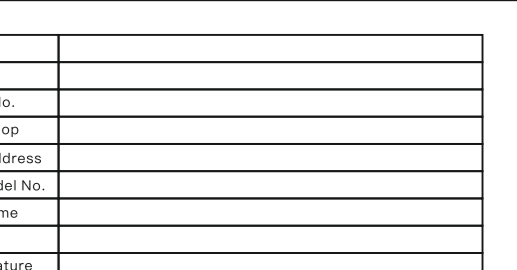

(68) Click Tunnel, Select binding device type, click EWEB to log in to the device.

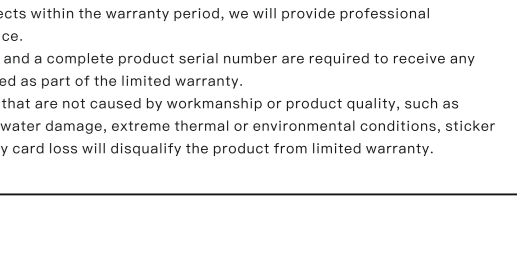

(69) Click Tunnel, Select binding device type, click EWEB to log in to the device.

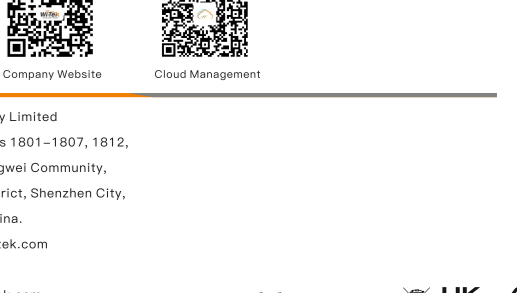

(70) Click Tunnel, Select binding device type, click EWEB to log in to the device.

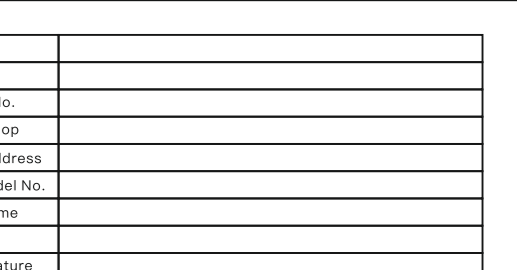

(71) Click Tunnel, Select binding device type, click EWEB to log in to the device.

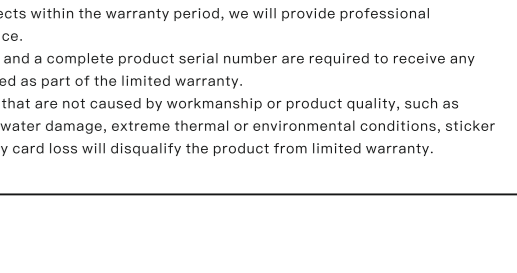

(72) Click Tunnel, Select binding device type, click EWEB to log in to the device.

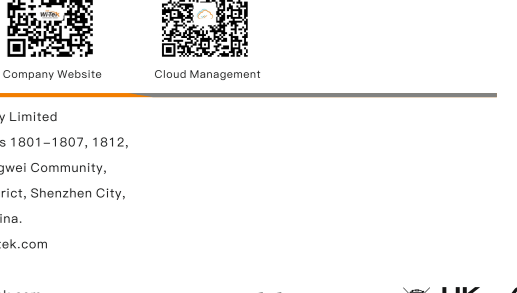

(73) Click Tunnel, Select binding device type, click EWEB to log in to the device.

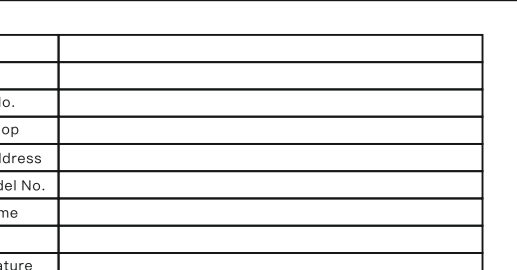

(74) Click Tunnel, Select binding device type, click EWEB to log in to the device.

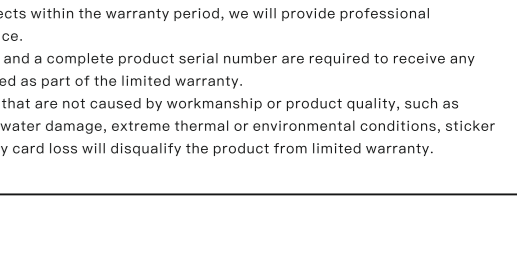

(75) Click Tunnel, Select binding device type, click EWEB to log in to the device.

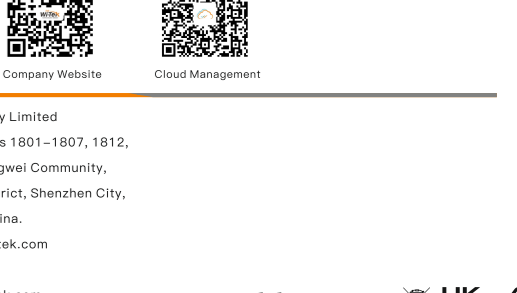

(76) Click Tunnel, Select binding device type, click EWEB to log in to the device.

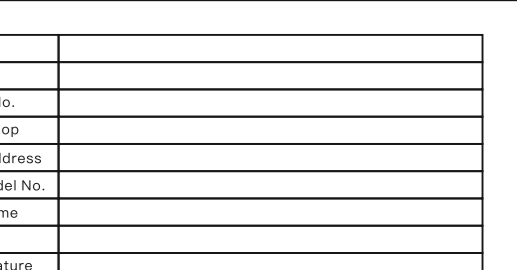

(77) Click Tunnel, Select binding device type, click EWEB to log in to the device.

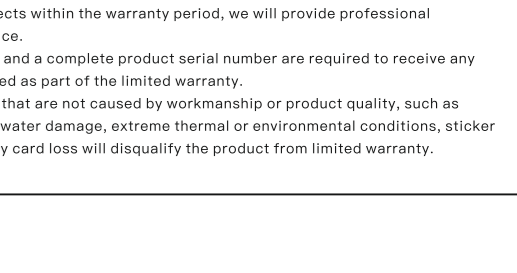

(78) Click Tunnel, Select binding device type, click EWEB to log in to the device.

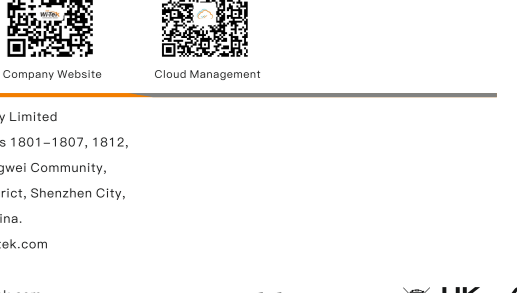

(79) Click Tunnel, Select binding device type, click EWEB to log in to the device.

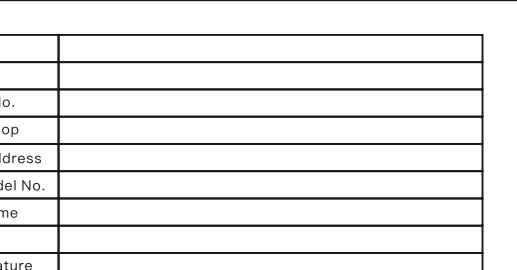

(80) Click Tunnel, Select binding device type, click EWEB to log in to the device.

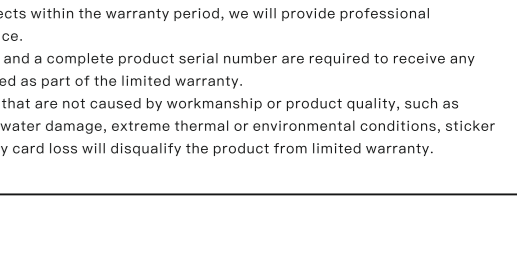

(81) Click Tunnel, Select binding device type, click EWEB to log in to the device.

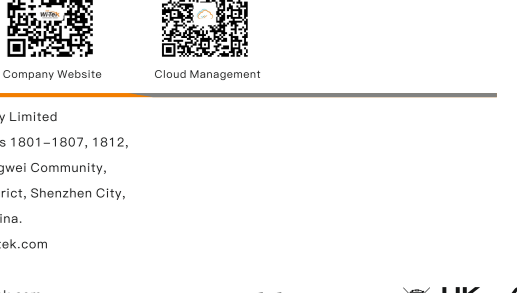

(82) Click Tunnel, Select binding device type, click EWEB to log in to the device.

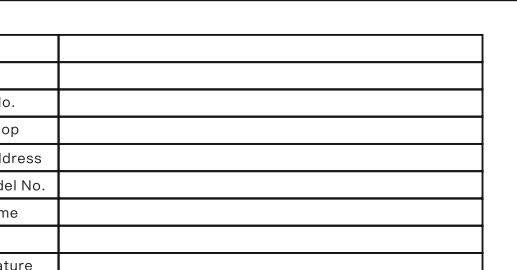

(83) Click Tunnel, Select binding device type, click EWEB to log in to the device.

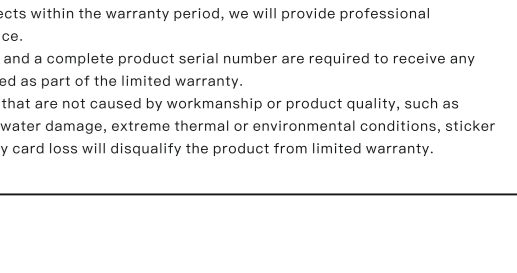

(84) Click Tunnel, Select binding device type, click EWEB to log in to the device.

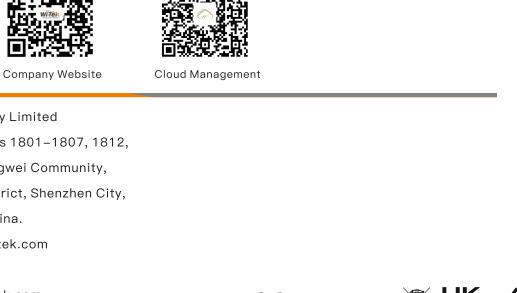

(85) Click Tunnel, Select binding device type, click EWEB to log in to the device.

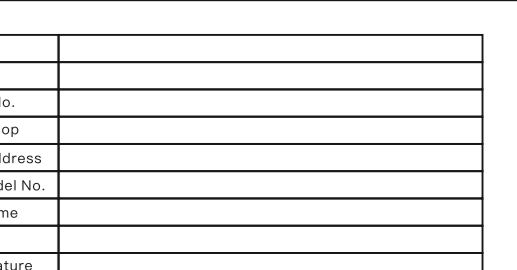

(86) Click Tunnel, Select binding device type, click EWEB to log in to the device.

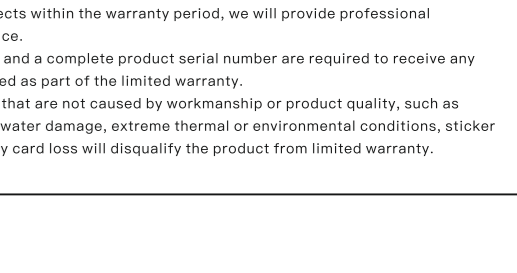

(87) Click Tunnel, Select binding device type, click EWEB to log in to the device.

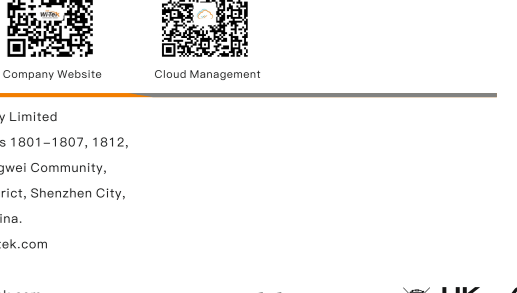

(88) Click Tunnel, Select binding device type, click EWEB to log in to the device.

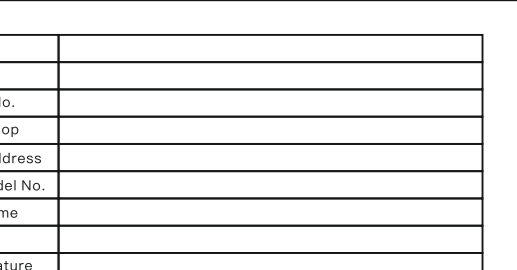

(89) Click Tunnel, Select binding device type, click EWEB to log in to the device.

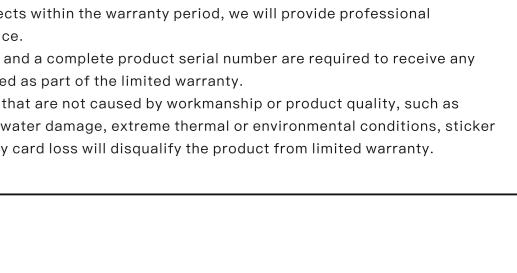

(90) Click Tunnel, Select binding device type, click EWEB to log in to the device.

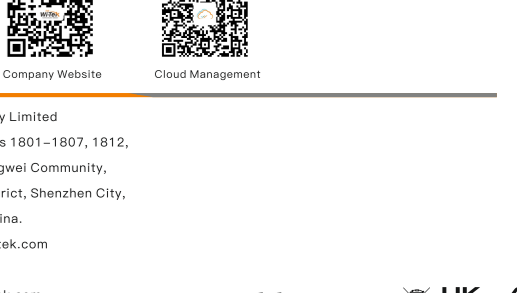

(91) Click Tunnel, Select binding device type, click EWEB to log in to the device.