

# Quick Installation Guide

Alien Series 24/48V Smart PoE Switch

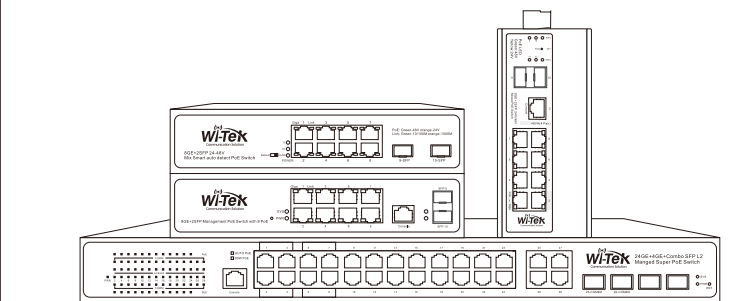

WI-PS310GF-Alien | WI-PMS310GF-Alien | WI-PMS310GF-Alien-I | WI-PMS328GF-Alien

## 1. Packing Content

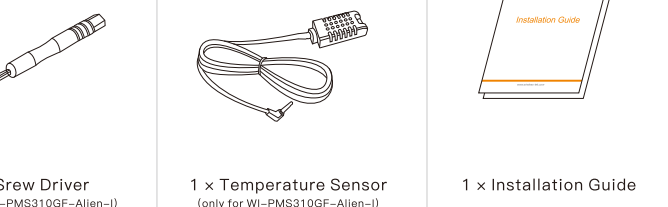
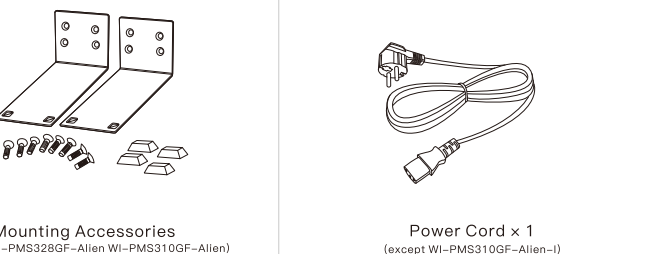
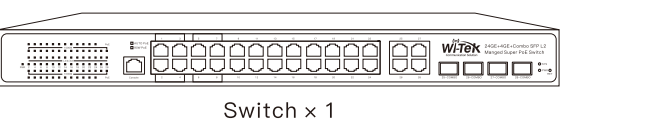

## 2. Appearance Overview

### WI-PMS328GF-Alien

#### • Front panel

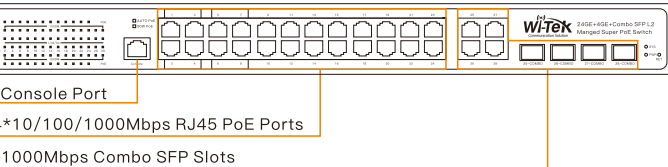

#### • Back panel

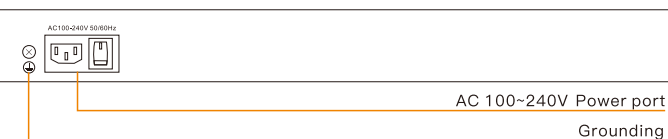

#### • LED indicator

LED Indicators	Description
PWR	On: the device power on is normal Off: the device is power off or failed
SYS	Blinking: device initialization On: device on and normal operation
PoE	Solid on: PoE is working Off: PoE not working
Link/Act	Blinking: Data transmission is active and working On: PD connected to the PoE port, but no data transmission
1000M	On: The port negotiated rate is 1000 Mbps Off: The port negotiated rate is not 1000 Mbps
25-28 (SFP Indicator)	Blinking: data on TX/RX On: ports link up Off: ports link down

### For WI-PMS310GF-Alien

#### • Front panel

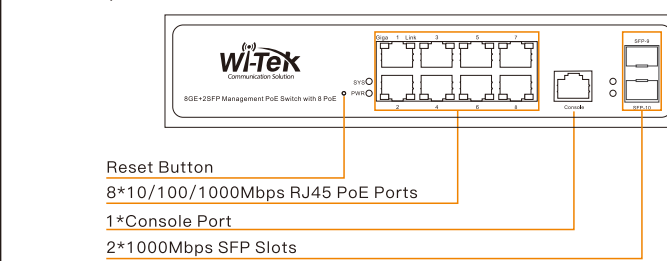

#### • Back panel

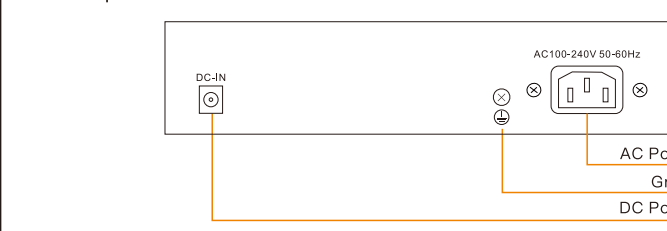

#### • LED Indicator and Button

LED Indicator	Description
PWR Indicator	On: the device power on is normal Off: the device is power off or failed
SYS Indicator	Blinking: device initialization On: device on and normal operation
Link/Act Indicator	Blinking: data on TX/RX On: ports link up Off: ports link down
Giga Indicator	On: The port negotiated rate is 1000 Mbps Off: The port negotiated rate is not 1000 Mbps
SFP Indicator	Blinking: data on TX/RX On: ports link up Off: ports link down
Reset	Hold for >5 sec. to restore factory default
Power Supply	DC 48-55V 5A Max or AC 110-240V 50/60HZ

### WI-PS310GF-Alien

#### • Front panel

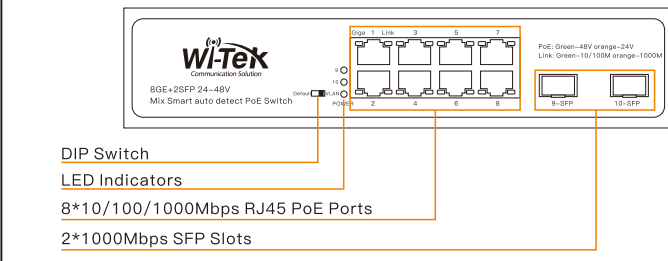

#### • Back panel

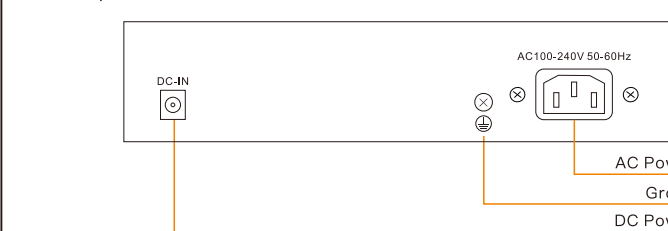

#### • LED indicator

WI-PS310GF-Alien DIP Switch Description	
Default	All ports free communication, suitable for common data transmission environment
VLAN	The PoE ports are isolated from each other but can only communicate with uplink ports, which can effectively restrain the broadcast storm and improve the performance of network
LED Indicators	
Description	
POWER	Solid on: The device power on is normal Off: The device is power off or failed
PoE	Green: Solid on: PoE is working with 48V power Off: PoE not working Orange: Solid on: PoE is working with 24V power Off: PoE not working
Link	Green: Blinking: Data transmission is active and working On: The port negotiated rate is 10/100 Mbps Orange: Blinking: Data transmission is active and working On: The port negotiated rate is 100/1000 Mbps
9, 10 (SFP Indicator)	Blinking: data on TX/RX On: ports link up Off: ports link down

### WI-PMS310GF-Alien-I

#### • Rack mounted installation

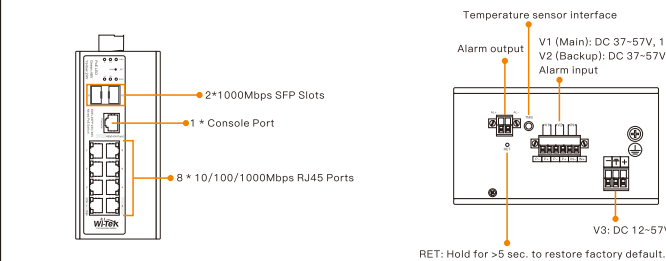

#### • LED indicator

LED Indicators	Description
PWR	On: the device power on is normal Off: the device is power off or failed
V1/V2 (Input power indicator)	On: Power is supplying via V1/V2 DC connector Off: No power supply
PoE	Green: Solid on: PoE is working with 48V power Off: PoE not working Orange: Solid on: PoE is working with 24V power Off: PoE not working
Link	Green: Blinking: Data transmission is active and working On: The port negotiated rate is 10/100 Mbps Orange: Blinking: Data transmission is active and working On: The port negotiated rate is 100/1000 Mbps
9, 10 (SFP Indicator)	Blinking: data on TX/RX On: ports link up Off: ports link down
Ring	On: The fast ring mode is enable Off: The fast ring mode is disable
Giga	On: The port negotiated rate is 1000 Mbps

## 3. Installation

### • Desktop installation (WI-PMS328GF-Alien, WI-PMS310GF-Alien, WI-PS310GF-Alien)

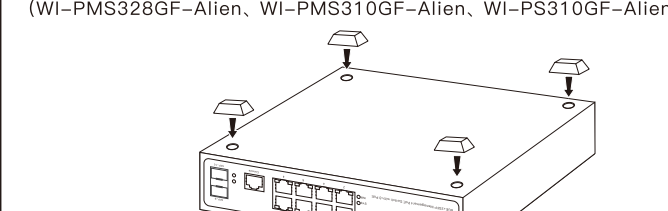

### • Rack mounted (WI-PMS328GF-Alien)

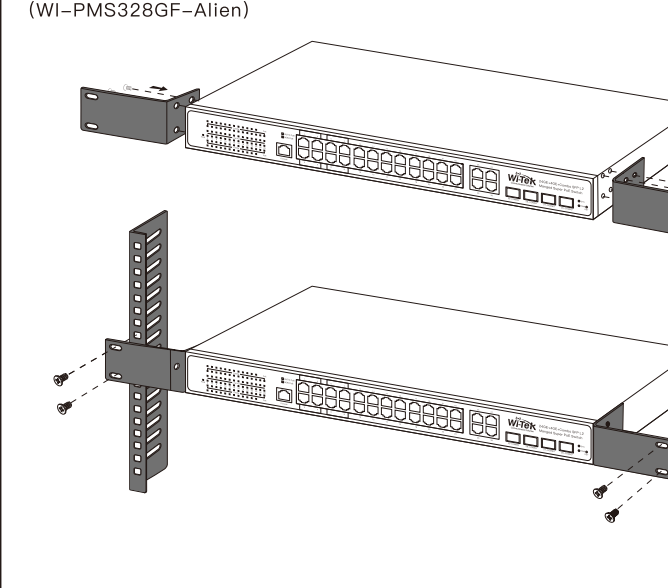

## 3. Installation

### DIN-rail Mount installation(WI-PMS310GF-Alien-I)

• Installing WI-PMS310GF-Alien-I, place the WI-PMS310GF-Alien-I in a desired location using the Din-rail fixtures.

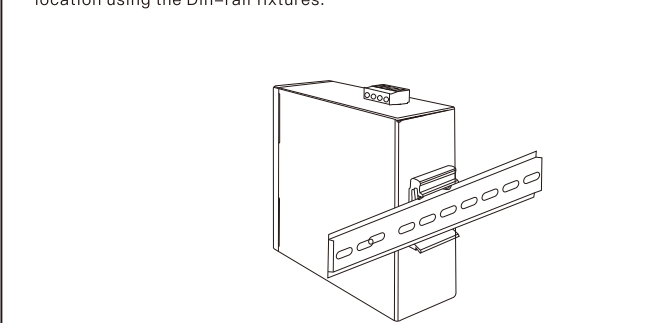

Please install the WI-PMS310GF-Alien-I in a proper enclosure or shelter. The WI-PMS310GF-Alien-I must be grounded.

## 4. Login WEB UI

For more L2 management functions, please login the Web-Based UI as the following steps:

Step 1. Find the IP address of the switch.

• The default login IP address of this series switch is 192.168.0.1, with a subnet mask of 255.255.255.0.

• If the switch receives an IP address from a DHCP server in your network. You can find this IP address on the DHCP server.

Step 2. Configure the IP address on your PC to make sure the switch and PC are in the same subnet.

• If the switch uses the static IP address of 192.168.0.1, configure your PC's IP address as 192.168.0.x ( "x" ranges from 2 to 254), and subnet mask as 255.255.255.0.

• If the switch uses an IP address assigned by a DHCP server, set your PC to obtain an IP address automatically from the DHCP server.

Step 3. Launch a web browser on your PC. Enter the IP address of the switch in the address bar and fill in the username and password.

• The default login username and password are both "admin".

## Warranty Card

Username	
Address	
Telephone No.	
Purchase Shop	
Purchase Address	
Product Model No.	
Purchase Time	
Serial No.	
Dealer Signature	

- If the product defects within the warranty period, we will provide professional maintenance service.
- Proof of purchase and a complete product serial number are required to receive any services guaranteed as part of the limited warranty.
- Any other defects that are not caused by workmanship or product quality, such as natural disasters, water damage, extreme thermal or environmental conditions, sticker damaged, warranty card loss will disqualify the product from limited warranty.



Wireless-Tek Technology Limited  
Address: Building 3, Units 1801-1807, 1812, Huaqiang Era Plaza, Tangwei Community, Fuhai Street, Bao'an District, Shenzhen City, Guangdong Province, China.  
Website: www.wireless-tek.com  
Tel: 86-0755-32811290  
Email: sales@wireless-tek.com  
Technical Support: tech@wireless-tek.com

